

# Processing and handling manual

The purpose of this Processing and Handling Manual is to provide the customer with a reference guide on the processing, installation and handling of HONEXT® Boards.

<a href="#">1. Data Sheet</a>	3
<a href="#">2. General description</a>	4
<a href="#">3. Machining</a>	6
<a href="#">3.1 Sawing</a>	7
<a href="#">3.2 Routing</a>	8
<a href="#">3.3 Tool recommendations</a>	10
<a href="#">3.4 Sanding and calibrating</a>	12
<a href="#">4. Bending</a>	13
<a href="#">5. Fixing and adhesives</a>	14
<a href="#">4.1 Screws and drills</a>	15
<a href="#">4.2 Pins and nails</a>	16
<a href="#">4.3 Adhesives</a>	17
<a href="#">4.4 Installation ideas</a>	18
<a href="#">5. Surface finishes</a>	21
<a href="#">5.1 Coatings</a>	22
<a href="#">5.2 Lamination</a>	24
<a href="#">5.3 Other techniques</a>	25
<a href="#">6. Maintenance</a>	26
<a href="#">6.1 Preserving and cleaning</a>	26
<a href="#">6.2 Repairs</a>	26
<a href="#">7. Transportation, storage and handling</a>	27
<a href="#">8. Sustainability</a>	28
<a href="#">9. Relevant information</a>	29

# 1. Data Sheet

PROPERTIES	REFERENCE TEST	UNITS	FR-C / FR-B
Density	EN 323	kg/m <sup>3</sup>	550-620 / 580-650
Content, emission and/or release of dangerous substances <sup>(1)</sup>	EN 16516	µg/m <sup>3</sup> (At 28 days)	85
Vapour permeability	ISO 12572:2018	µ	2,7
Reaction to fire <sup>(2)</sup>	EN 13823 (SBI)	Euroclass	C-s1,d0 / B-s1,d0
Airborne sound insulation (surface mass)	ISO 354:2004	dB	24
Acoustic absorption	ISO 354:2004	α <sub>w</sub>	0,15
Thermal conductivity	EN 12664:2002	W/m·K	0,1
Dimensional stability (variation of length)	EN 318	mm/m	2,2
Dimensional stability (variation of thickness)	EN 318	%	1,9
Impact resistance <sup>(3)</sup> (soft impact body energy)	EAD 210132-00-0504	N·m	1,200
Impact resistance <sup>(3)</sup> (hard impact body energy)	EAD 210132-00-0504	N·m	10
Thickness tolerance		mm	±0,50

(1) The HONEXT® Board emission results according to basic level emission criteria of BREEAM Int.: Hea 02 Indoor air quality:

- Carcinogenic substances were not detectable after 28 days (< 0,001 mg/m<sup>3</sup>).
- The sum of VOC ("TVOC") after 28 days was below the limit of 1,0 mg/m<sup>3</sup>.
- Formaldehyde after 28 days was below the limit of 0,06 mg/m<sup>3</sup>.

(2) Valid when the HONEXT® Board is installed:

- Screwed to a substrate with reaction to fire A2-s1,d0 or higher.
- Screwed to a metal frame and the back side of the frame fixed to a substrate with reaction to fire A2-s1,d0 or higher.

(3) Valid when the HONEXT® Board is installed:

The HONEXT® Board does not show collapse, penetration nor projection after the impacts. The energies tested are the highest energies considered by EAD 210132-00-0504.

- Screwed to any substrate.
- Screwed to a metal frame and the back side of the frame fixed to any substrate.

Properties tested by Applus in 2021.

## UNIQUE SPECIFICATIONS

## VALUES

Raw material	Paper mill primary sludge and post-consumer cardboard
Recyclability	Recyclable
Cradle to Cradle Certified® GOLD	Material Health Gold Level version 4.0
CE Marking and ETA	Expected by H2 2023



## 2. General description

### A. THE RAW MATERIAL

The HONEXT® Boards use both paper sludge and OCC (old, corrugated cardboard) as well as residual industrial fibres. Due to the origin of its raw material, its low environmental impact in manufacturing, use and end-of-life solutions allowing for recyclability, and its non-toxicity, the HONEXT® Board has an overall Cradle to Cradle Silver Certification, including Gold in Material Reutilization and Renewable Energy and Carbon Management. It lowers the carbon footprint of buildings where it is applied which increases LEED and BREEAM credits.

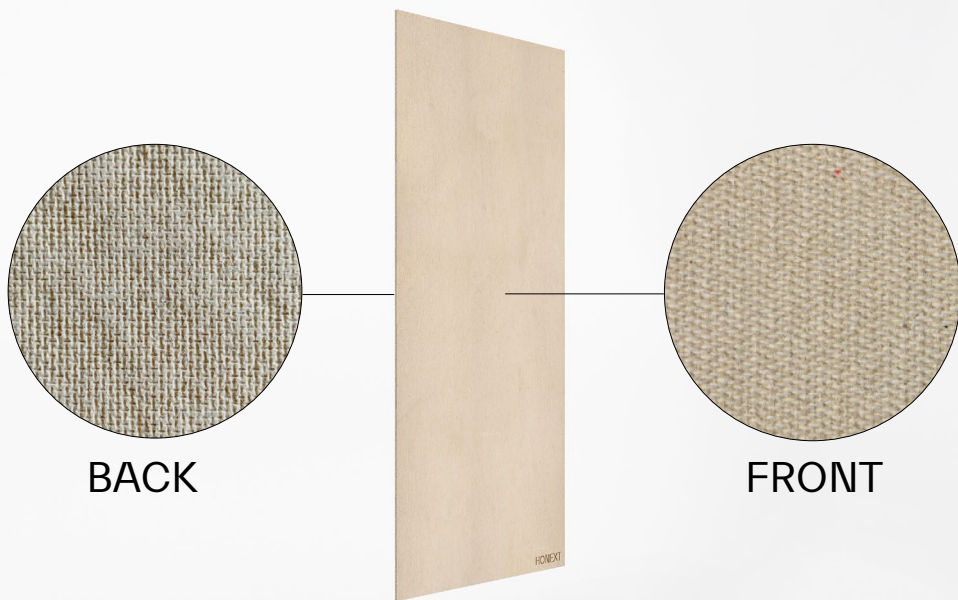

BACK

FRONT

### B. PHYSICAL CHARACTERISTICS

Measures: 2440×1220×12 mm

Thickness tolerance: +/- 0,5mm

Weight: 20.6 kg

Density: FR-C: 550–600 kg/m<sup>3</sup>, FR-B: 580–650 kg/m<sup>3</sup>

Every board has its own unique natural characteristics. The boards are made with a wet process from cellulose paper waste which results in range of light beige and grey tones and subtle watermarks from the drying process. Each side of the board is differently textured as a result of the water filtering meshes used during the manufacturing process.



## C. APPLICATIONS

HONEXT® Boards have competitive mechanical and thermodynamic properties for applications in the interior built environment, with most common uses in offices, shop fitting, exhibitions, wall cladding and ceilings, and furniture parts.

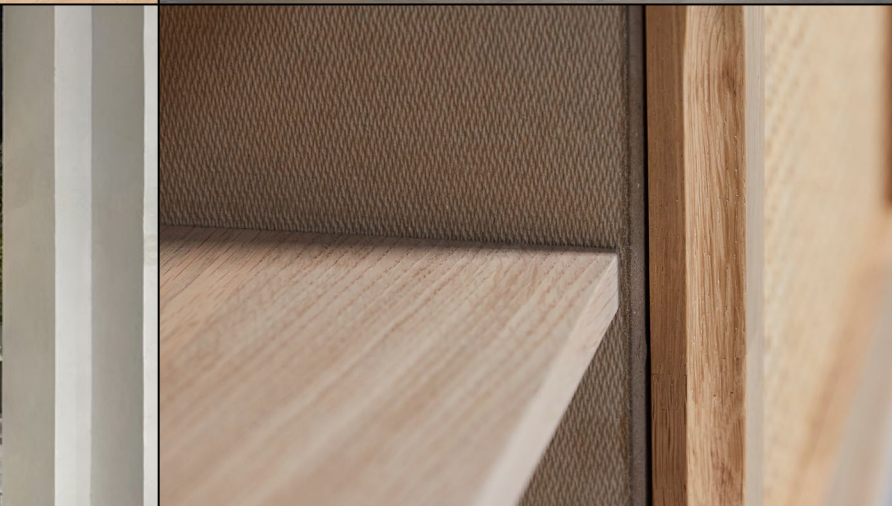
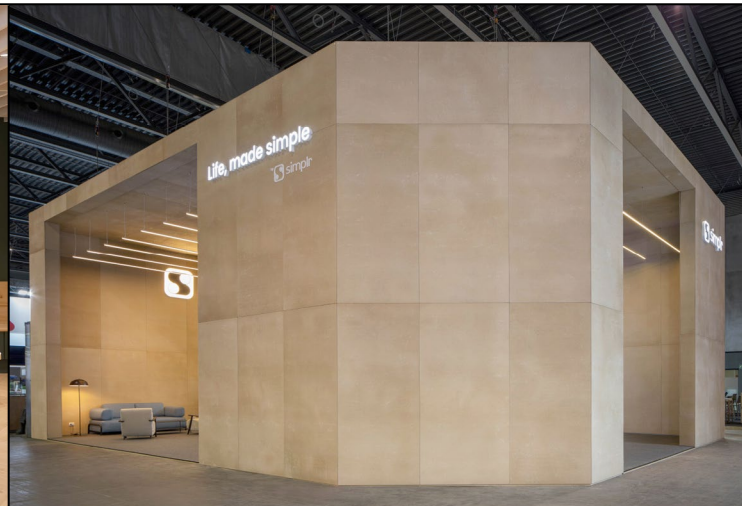



## 3. Machining

### A. EQUIPMENT

HONEXT® Boards can be machined using standard equipment and processes commonly applied in wood-based fiberboards. The best tools for cutting and drilling HONEXT® are Circular saws and CNC machines although any other traditional wood cutting/processing machines will work as well. For cutting tools we recommend using tungsten carbide. ([See tool recommendations in section 3.3](#))

### B. HIGH RPM VALUES

The boards have short fibres and no resin binders, therefore higher RPM values are required to achieve the same results expected from fibreboards or aligned materials. (For routing, follow the [chip load recommendations in section 3.2](#))



### C. DUST

The dust generated when processing HONEXT® is dense but is not toxic and does not produce Formaldehyde or VOC's. Regardless, dust should never be inhaled, and the use of protection gear and extraction systems is highly recommended. Please consult the Material Safety Data Sheet in “downloads” on our website [honextmaterial.com](http://honextmaterial.com) for further details.



## 3.1 Sawing

### A. CIRCULAR SAW

Circular saws work best when sawing HONEXT® although jig and bandsaws will as well give great results. The more number teeth your blade has, the cleaner and more dense the cut will be. The cut speed should not be more than 1–2m/sec with the blade turning at 4500+ rounds per minute.



### B. BEST BLADE

Blade: Fine cut composite blades

Teeth: 80+

Cut speed: 1–2m/sec

RPM: 4500+

Note: Use tooth combination with alternate angle of cutting face for best cutting results.  
([See tool recommendations in section 3.3](#))

## 3.2 Routing

### A. CNC

HONEXT® Boards can be easily shaped and profiled using CNC technologies. As mentioned above, higher RPM values are required to achieve the same results expected from fibreboards or aligned materials. To avoid tool wear and burns, the tool in use should never reach more than 300 degrees Celsius.

### B. ROUTER BITS

In collaboration with experienced tool manufacturers, we have developed lists of tool recommendations for the most common processes.



## Recommended router bits

#### 1. PROFILING AND ENGRAVING

DIXI 7306, 5–8mm diameter, 2 flutes, compression  
Chip Load 0.03 - 0.045



#### 3. DRILLING

DIXI 1290, 3 - 8mm diameter, 2 flutes, extraction  
Chip Load: 0.04 - 0.06mm



#### 5. ENGRAVING AND SHAPING

DIXI 7834, 6 - 25mm diameter, 4 flutes, extraction.  
Chip Load: 0.01 - 0.026mm



#### 7. ENGRAVING AND EDGING

DIXI 7628, 20mm diameter, 2 flutes, straight  
Chip Load: 0.025mm



#### 2. PROFILING, ENGRAVING AND EDGING

DIXI 7112, 5–8mm diameter, 2 flutes straight  
Chip Load: 0.03 - 0.045mm



#### 4. ENGRAVING AND SHAPING

DIXI 7032, 12 - 16mm, 2 flutes, extraction.  
Chip Load: 0.015 - 0.03mm



#### 6. POCKETING AND FACING

DIXI 7800, 20 - 35mm diameter, 4 - 6 flutes, straight  
Chip Load: 0.01 - 0.017mm





## Chip Load chart

\*Chip Load = Feed Rate (mm or inches per minute) / (RPM x number of flutes)

TOOL DIAMETER	HONEXT®	HARD WOOD	PLYWOOD	MDF/PARTICLE	SOFT PLASTIC	HARD PLASTIC	COMPOSITES
3mm	0.02 - 0.04	0.08 - 0.13	0.10 - 0.15	0.10 - 0.18	0.08 - 0.15	0.05 - 0.1	0.08 - 0.13
6mm	0.03 - 0.04	0.23 - 0.28	0.28 - 0.33	0.33 - 0.41	0.18 - 0.26	0.15 - 0.23	0.23 - 0.31
10mm	0.04 - 0.05	0.41 - 0.46	0.43 - 0.51	0.51 - 0.59	0.26 - 0.31	0.20 - 0.26	0.41 - 0.46
13mm - >	0.05 - 0.06	0.48 - 0.54	0.54 - 0.59	0.64 - 0.69	0.31 - 0.41	0.26 - 0.31	0.59 - 0.64
1/8 inch	.0008 - .0015	.003 - .005	.004 - .006	.004 - .007	.003 - .006	.002 - .004	.003 - .005
1/4 inch	.0011 - .0015	.009 - .011	.011 - .013	.013 - .016	.007 - .010	.006 - .009	.009 - .011
3/8 inch	.0015 - .0019	.015 - .018	.018 - .020	.020 - .023	.010 - .012	.008 - .010	.015 - .018
1/2 inch - >	.0019 - .0023	.019 - .021	.021 - .023	.025 - .027	.012 - .016	.010 - .012	.019 - .021

## C. GENERAL PARAMETERS

HONEXT® Boards have to be routed with high revolution values to obtain clean results. The recommended speeds and feeds for CNC machining can be determined by using the Chip load chart\* on the left.

\*A chip load chart is used for determining proper feed rates when cutting various materials and using various tools. It is a part of how tools perform in terms of cut quality and tool life. Chip load per tooth is the appropriate amount of material that one cutting edge of the tool should remove in a single revolution.

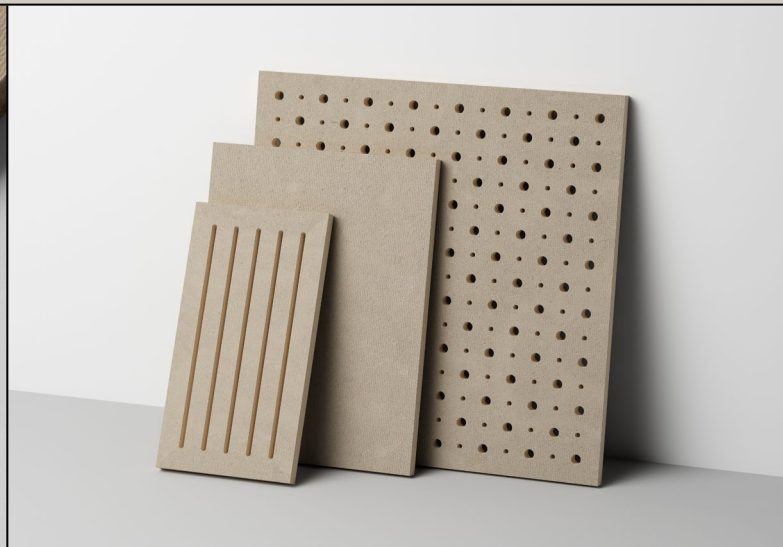

### 3.3 Tool and Machining recommendations

#### 1. CIRCULAR SAWBLADES

**HW Sizing circular sawblade Katana** 163121

D303×3.2/2.2×30; Z100, WZ/WZ/FZ; n 3000–4500 min-1

**DP Sizing circular sawblade WhisperCut** 190698

D303×3.2/2.4×30; Z60, HZFA/WZFA; n 3000–4000 min-1  
 Ü = 20–30 mm, suitable scoring circular sawblade on request

**HW Panel sizing circular sawblade** 163302

D350×4.4/3.2×30; HW, Z72, WZ; n 3500–4700 min-1, fz0.05–0.07 mm

**HW Scoring circular sawblade** 165569

D200×4.4×20; Z36, KON/WZ

#### 2. HOGGERS

**HW Segment hogger** 064410 + 061878

250×29×80; Z48, ES; n 6000 min-1, vf 25–30 m/min

064411 + 061879

**DP Compact hogger DT Score** 190444

250×10×60; Z36; n 6000 min-1, vf 25–30 m/min

190445

#### 3. JOINTING CUTTERS

**DP Jointing cutter WhisperCut** 075627

D125×43×30; Z3×4; n 9000 min-1, vf 15–20 m/min

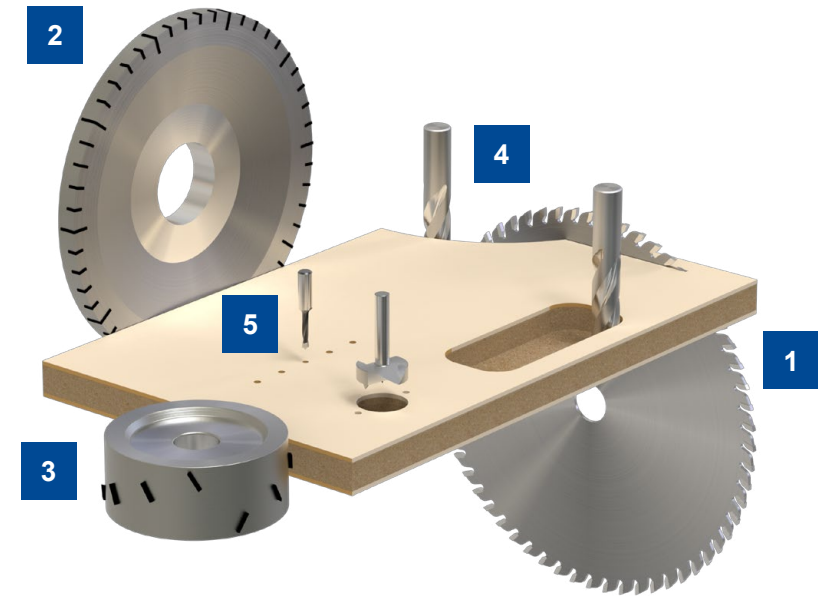

HW = Cutting material tungsten carbide for multi-purpose use.

DP = Cutting material Diamond for longer tool life.  
 (recommended for abrasive working material)

Z = Number of teeth

D = Diameter

n = Speed

S = Shank dimensions

vf = Feed speed

GL = Total length

fz = Tool feed

NL = Effective length

U = Sawblade protrusion



## 4. ROUTER CUTTERS

**HW Finishing cutter Marathon, right-hand twist** 042790

D12, NL35, S12×40, GL80; Z3; n 18000–24000 min<sup>-1</sup>, vf6–12 m/min

**HW Finishing cutter, alternating twist** 042536

D12, S12×40, NL25, GL70; Z2+2; n 18000–24000 min<sup>-1</sup>, vf6–12 m/min

**DP Router cutter Diamaster PRO** 091190

D18, NL25, S16×50, GL90; Z2; n 18000–24000 min<sup>-1</sup>, vf6–12 m/min

## 5. ROUTER DRILL BITS

**HW Dowel drill Excellent** 033501

D8, S10×25, GL70; Z2; n 4500 min<sup>-1</sup>, vf1.5–2.0 m/min

**HW hinge boring bit** 037214

D35, S10×26, GL70; Z3; n 3500 min<sup>-1</sup>, vf1.5–2.5 m/min

### Note:

The indicated tools are exemplary dimensions. The recommended application parameters refer to the specified tool designs.

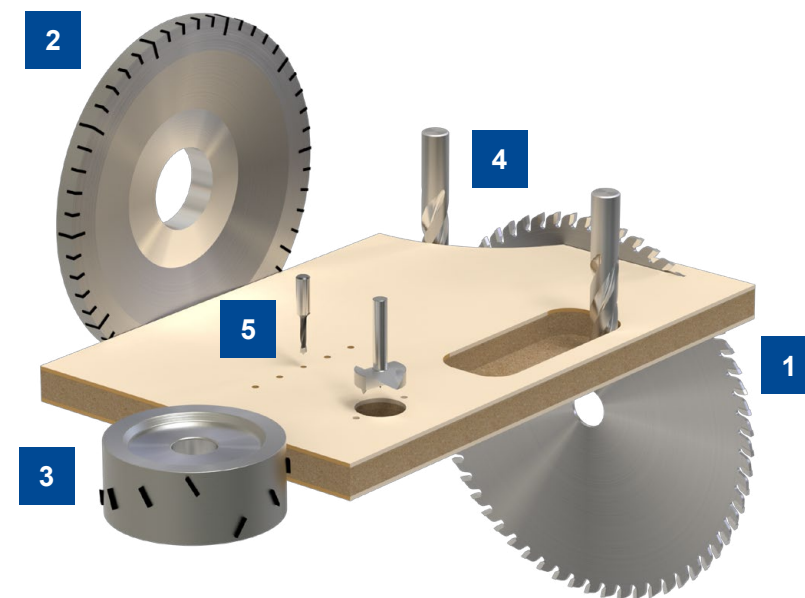

HW = Cutting material tungsten carbide for multi-purpose use.

DP = Cutting material Diamond for longer tool life.  
(recommended for abrasive working material)

Z = Number of teeth

D = Diameter

n = Speed

S = Shank dimensions

vf = Feed speed

GL = Total length

fz = Tool feed

NL = Effective length

U = Sawblade protrusion

## 3.4 Sanding and Calibrating

### A. EQUIPMENT

The surface and edges of the HONEXT® Board can be sanded using standard equipment and processes commonly applied for wood-based boards. Industrial belt sanders should be used for calibrating the boards, specially before for lamination with other sheet materials.

### B. PROCESS

It is always recommended to apply the same process on both sides of the board to avoid tensions. To remove textures or watermarks the boards can be calibrated and sanded. Completely sanding the outer layers of the board until removing the textures may cause a reduction of the material's mechanical properties, as well as increase its porosity.



### C. SANDPAPER

**Paper type:** Garnet and Flint  
**Rough calibration:** Grit 80-150  
**Smooth finish:** Grit 200-320



## 4. Bending

### A. THE RAW MATERIAL

HONEXT® does not require mechanization, water, steaming or adhesives to be bent. The raw board can be bent to a 120cm radius on all axis before the risk of breaking. When left under pressure the tension leaves the material and the board remains in shape of the mold. The same board can be pressed flat again.

### B. KERFING

Kerfing is an ideal process for HONEXT® as the surface skin is highly flexible and allows for steep kerfing. (See photo below)





## 5. Fixtures and adhesives

### A. FIXTURES

HONEXT® can be mounted using the most standard fixing and installation methods. Wood screws, glues, bolt inserts and biscuit joinery are ideal when working with HONEXT®. Most interior paneling systems work when installing prefabricated HONEXT® Boards.

### B. TIPS

- Maximum distance between fixtures: 45cm
- Use structural grids rather than point systems to avoid unwanted curvature. If point systems are used make sure the distance between fixtures is not greater than 45 cm
- Use of adhesive is recommended for permanent installation on a wooden structure. ([See glue recommendations in section 5.3](#))

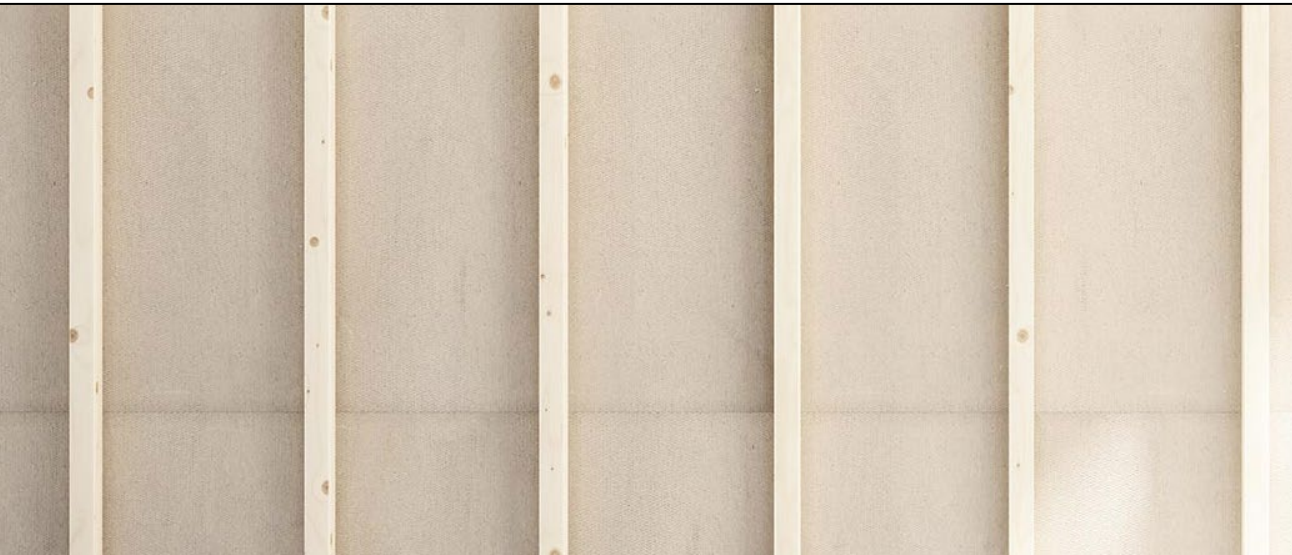

## 5.1 Screws and Drills

### A. BEST SCREWS

Most wood screws and inserts will work on HONEXT® boards. For best performance use particle board or parallel thread screws. Use wider thread screws to increase the screw load. Screws should not be overtightened as will reduce the load.

### B. TENSILE LOAD

Test: EN320

(European Standard, Particleboards and fibreboards - Determination of resistance to axial withdrawal of screws.

HONEXT® Density 550kg/m<sup>3</sup>:

**618 Newton or 63kg/cm<sup>2</sup> per screw.**

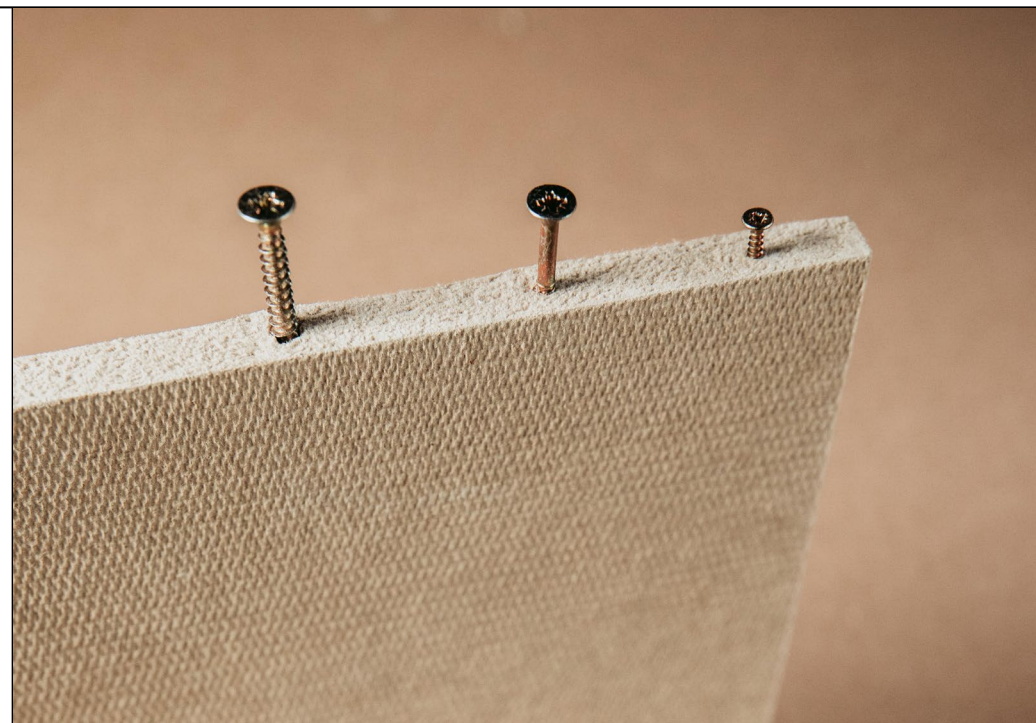

### A. BEST DRILLS

Wood twist or tapered drill bits are most suitable for manually drilling HONEXT®.

### B. PILOT HOLES

Due to the wet manufacturing process the fibres within the boards do not have any specific direction. Therefore HONEXT® does not split as easily as other fibreboards when screwing on their edges or main surfaces. However, it is always recommended to drill a pilot hole for maximum performance. The pilot hole should be drilled 2 mm deeper than the inserted screw.





## 5.2 Pins and nails

Pinning and nailing can be used to install HONEXT® in cladding and covering applications when structural performance is not needed. The boards can be pinned on grid structures using a pneumatic nail gun. When installing HONEXT® on a wooden structure, we recommend using also PVA glue for best performance.

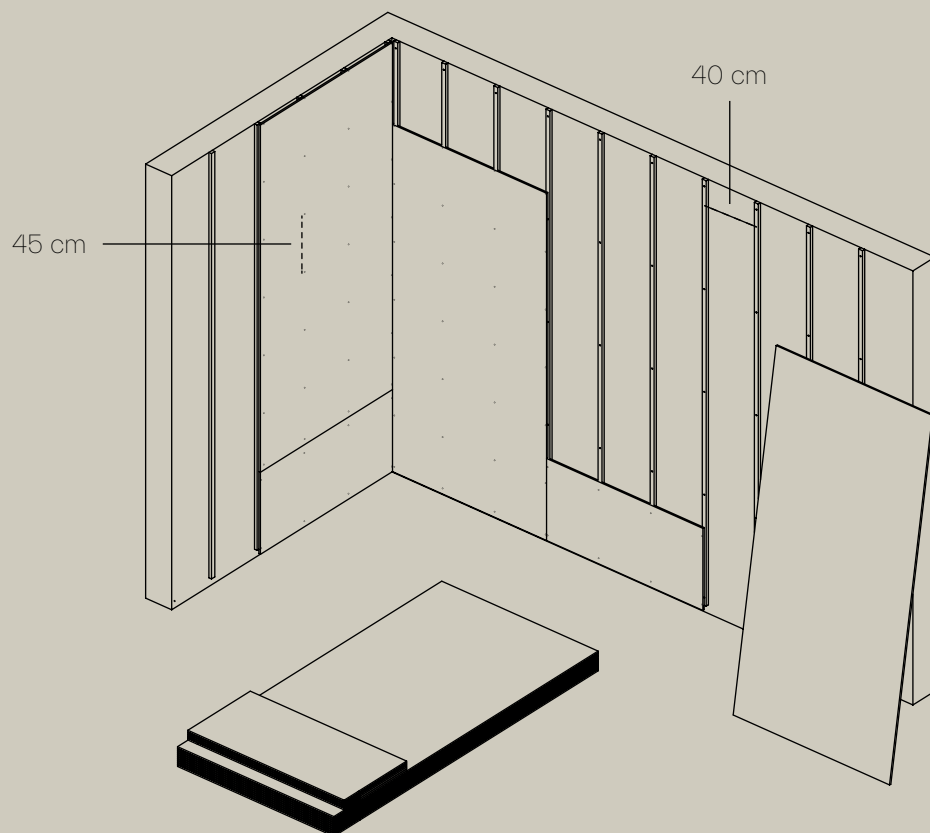
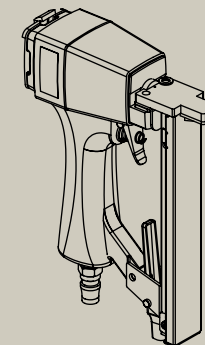

### A. Nail type

Annular grooved or spiral nails.

### B. Nail size

With 12mm board thickness the nail should not exceed 40mm.

### C. Distance from corner

At least 15mm from the corner of the board.

### D. Nail load

Nailing at a slight angle will increase the load capacity.



## 5.3 Adhesives

HONEXT® can be glued and laminated using standard industry equipment and adhesives. The boards can be glued and laminated to multiple materials for various applications. The material offers great bonding results as the absorption is higher than resin-based fibreboards. To avoid impact on the board's recyclability we always recommend using non-toxic adhesives.

### RECOMMENDED LOW EMISSION ADHESIVES

**Materials:** HONEXT®, Solid wood, Wood veneer, OSB, MDF, HPL, Gypsum board, Linoleum

Glue: PVAc : 8550  
 Ratio: Monocomposant  
 Grammage (g/m<sup>2</sup>): 170  
 Press temp. (C°): 0–45°  
 Press time (min): 3  
 Stab. time (Hour): 24.

**Materials:** HONEXT®, Mortar, Concrete, Wall plaster, Solid wood, Wood veneer, OSB, MDF, HPL, Gypsum board, Linoleum

Glue: EPI : 4421/1993  
 Ratio: 100/151  
 Grammage (g/m<sup>2</sup>): 170  
 Press temp. (C°): 0–50°  
 Press time (min): 3  
 Stab. time (Hour): 2

**AkzoNobel**



Formaldehyde-free  
 solutions for gluing  
 HONEXT® Boards with  
 other surface materials.

# 5.4 Installation ideas

## A. HANGING SYSTEM

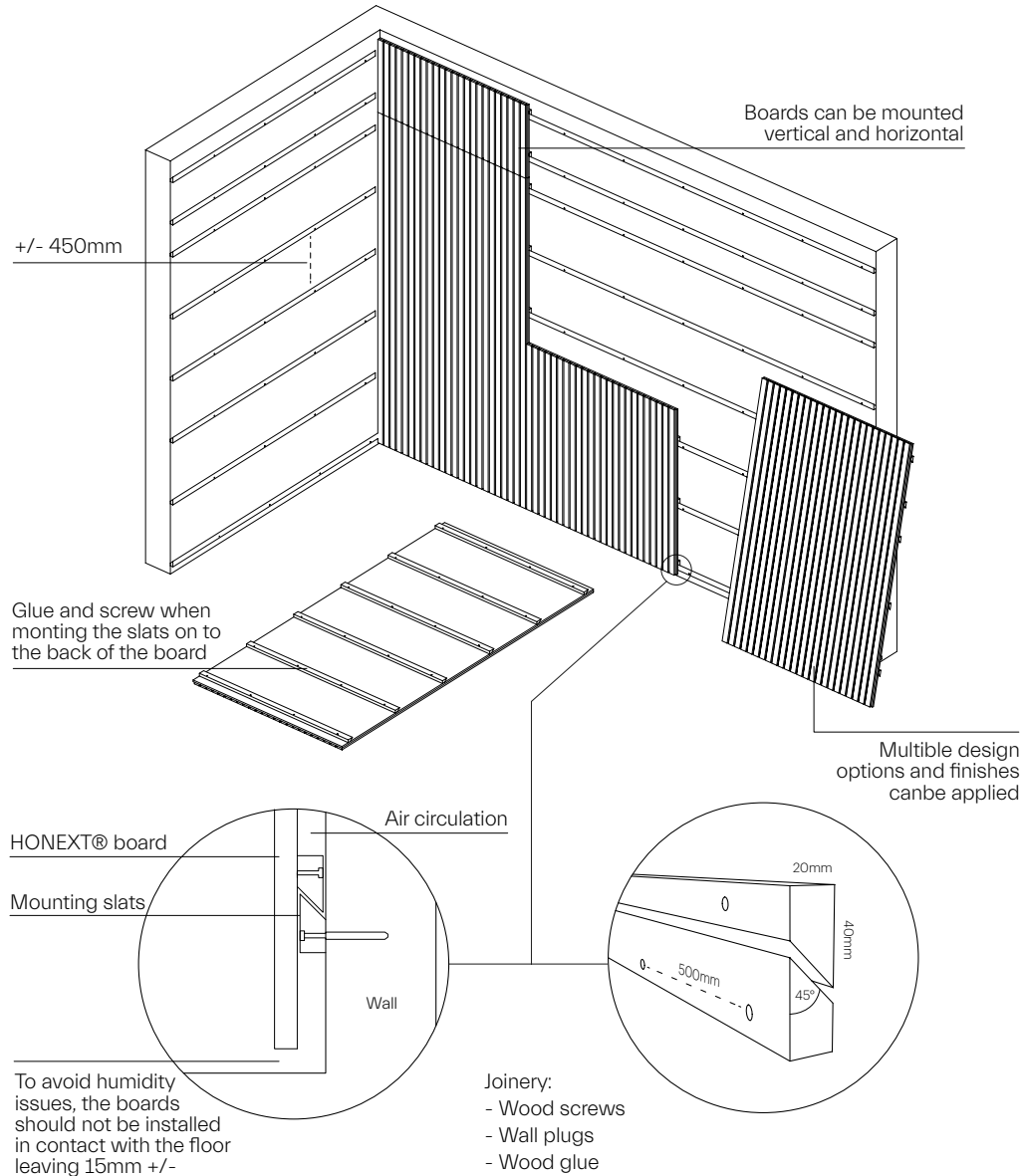

We recommend to acclimate the boards to the final temperature and humidity conditions of the room at least 48 hours prior to installation. We also recommend to leave gaps between battens to facilitate air circulation behind the cladding.

Patterns:

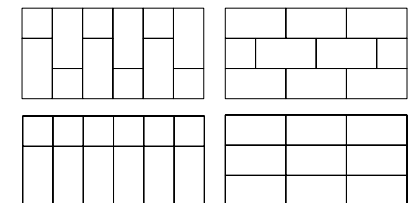



## B. ACOUSTIC ISLAND

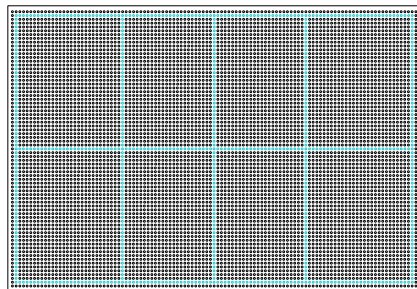
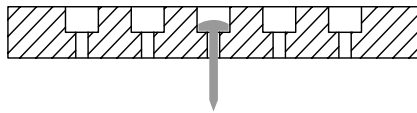
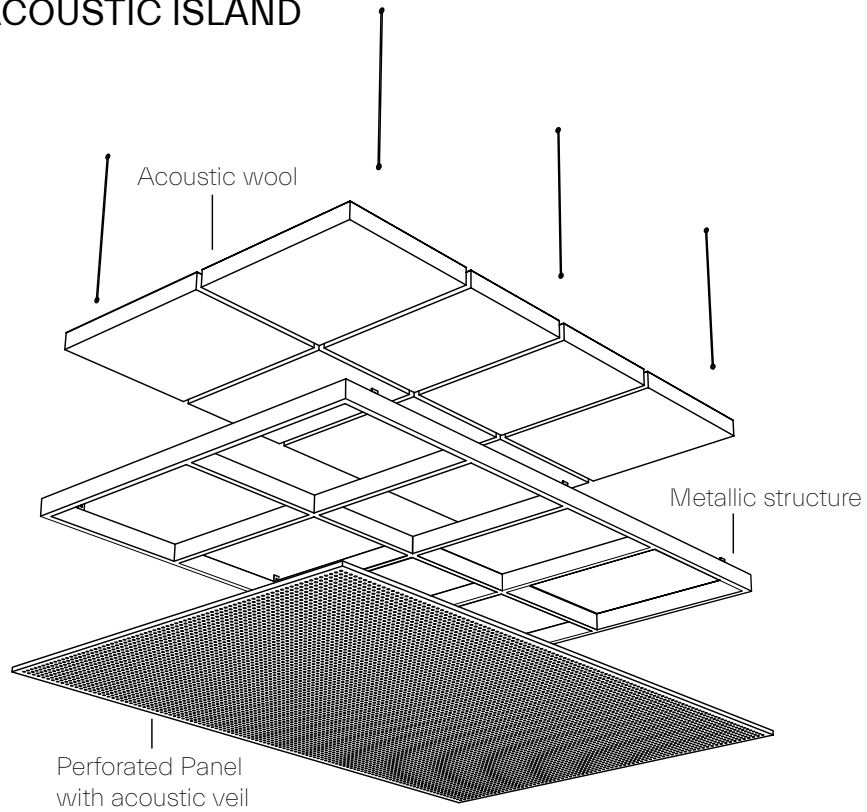

C. PINNING / SCREWING

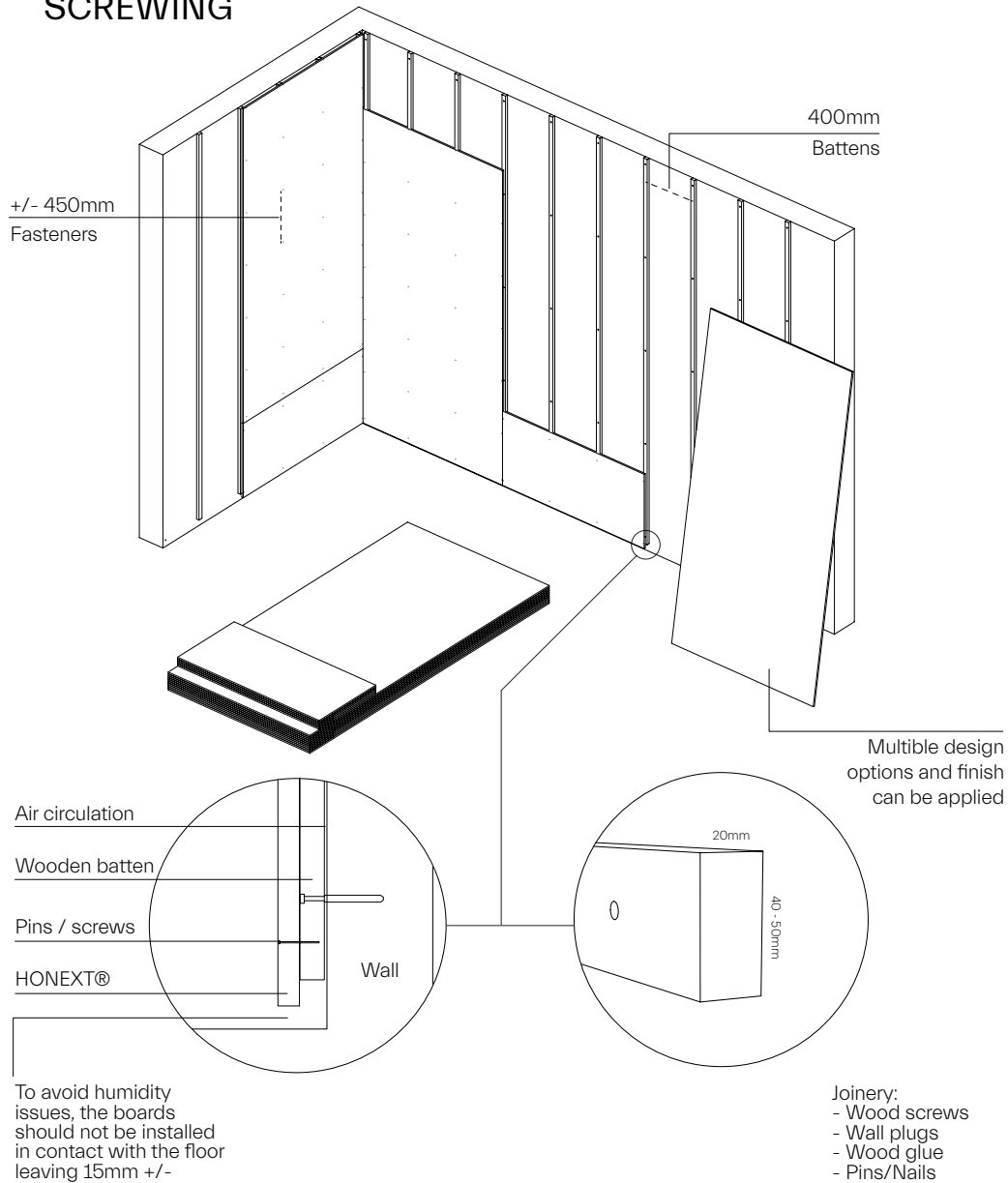

We recommend to acclimate the boards to the final temperature and humidity conditions of the room at least 48 hours prior to installation. We also recommend to leave gaps between battens to facilitate air circulation behind the cladding.

Patterns:

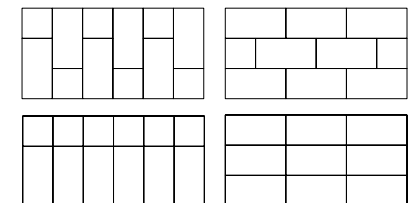



## 6. Surface finishes

Any surface finish can be achieved using the right process and product. HONEXT® can be coated, printed or laminated with most common types of paints, oils, lacquer, varnishes or sheet materials.

### A. PROCESS

Surface finishes must be equally applied on both sides or compensated to avoid any tensions in the board. A single-sided finish should only be applied when the product is fixed to a solid structure or surface. To minimize the material absorption, use a fast-drying sealant before applying the final finish.



### B. RECYCLABILITY

From an environmental perspective, it is always better to use water-based surface additives and renewable or recyclable sheet materials when laminating. HONEXT® Boards can still be recycled if the finish does not exceed 5% of the total volume.



## 6.1 Coatings

HONEXT® Boards can be treated with the most common products for wood-based materials. The use of a sealing coating is always recommended to increase the durability and resistance of the boards. For best performance it is recommended to follow the coating's application manual. Any application method can be used on HONEXT®.

### A. APPLICATION

Coatings can be applied using any type of coating equipment. In general, it is advisable to apply a fast-drying primer before painting to seal the board's pores and decrease the absorption. As well some solvent-based varnishes might accentuate the natural pigments found in the material, causing stains or spots on the board's surface. Coatings must be equally applied on both sides of the board to avoid tension. A single-sided finish should only be applied when the board is fixed to a solid structure or surface.

### B. DRYING

Let the board dry on a flat surface to avoid deformations.



### C. SUSTAINABILITY

- Always use water-based non-diluted products. If a solvent-based product is used, the chemical smell of the product can persist.
- Never use more coating than 5% of the boards volume to ensure recyclability.
- Natural products based on waxes and oils commonly used on wood materials as well deliver aligned results when applied to HONEXT®.

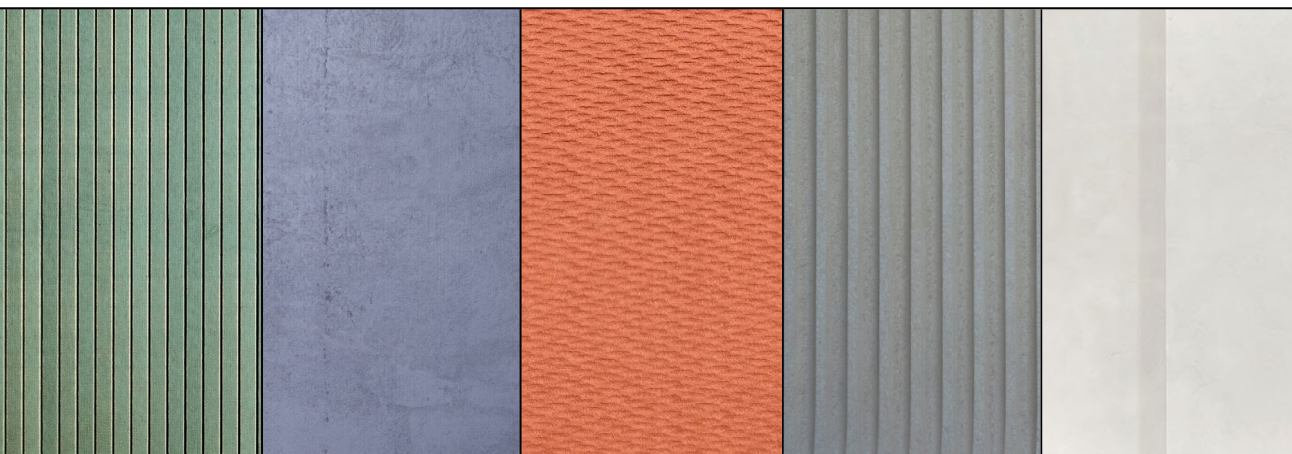



## C. RECOMMENDED PRODUCTS

The products recommended are all water-based and also used in wood and wood-based materials. If used less than 5% of the total volume of the material, they do not affect the potential recyclability of HONEXT®:

**AkzoNobel**



			
<p><b>Transparent sealant - Fast drying - High coverage</b></p> <p><b>Product:</b> Aqualit A-S130  <b>Coats:</b> 2x 100 gr/m2.  <b>Application :</b> Spray  <b>Manufacturer:</b> AkzoNobel  <a href="#">More information</a></p>	<p><b>Natural or tinted</b></p> <ul style="list-style-type: none"> <li>- Little Chemical resistance</li> <li>- Fireproof Certificate Bs1d0</li> <li>- Excel Plus Environmental Certificate</li> </ul> <p><b>Product:</b> Cetol WF 771  <b>Coats:</b> 2x tinted 60-100 gr/m2  <b>Application:</b> Spray  <a href="#">More information</a></p>	<p><b>Natural or Solid colour - High resistance</b></p> <ul style="list-style-type: none"> <li>- High chemical resistance</li> <li>- Low VOC's</li> </ul> <p><b>Products:</b> Aqualit AT 260-XX  <b>Coats:</b> 120 gr/m2  <b>Application:</b> Spray  <a href="#">More Information</a></p>	<p><b>Natural or Solid colour - High resistance</b></p> <ul style="list-style-type: none"> <li>- High chemical resistance</li> <li>- Low VOC's</li> </ul> <p><b>Products:</b> FA1019 by ICA Iberia  <b>Coats:</b> 120 gr/m2  <b>Application:</b> Spray  <a href="#">More Information</a></p>

## 6.2 Lamination

### A. PROCESS

HONEXT® is ideal substrate for laminating with natural wood veneer, vinyls, printed papers, foils and other sheet materials. Standard equipment and processes in line with other wood-based boards can be applied. For greater thicknesses HONEXT® can be glued and pressed together forming a thicker board, then calibrated to different thicknesses. After usage it can be recycled only if it is separated from the sheets.

### B. GLUES AND EQUIPMENT

It is recommended to calibrate the boards before laminating to improve adhesion. The material withstands the use of hydraulic hot and cold plate presses, with common industrial urea-based adhesives, aqueous dispersion adhesives based on polyvinyl acetate (white glue) and solvent-based polychloroprene (contact adhesive). ([See recommended glues in section 5.3](#))

Average settings:

Pressure: 150 kg/m<sup>3</sup>

Temperature: 95–100 °C

Time: 280 sec



### C. EDGING

The edges of HONEXT® Boards can be laminated continuously, industrially or manually in line with wood-based boards. Make sure you have a clean and dense cut before applying the edging.





## 6.3 Other interesting techniques

### A. DIGITAL PRINTING

HONEXT® is an ideal material for digital printing technologies. As it is based with paper fibres it results in clear colours and high resolution.

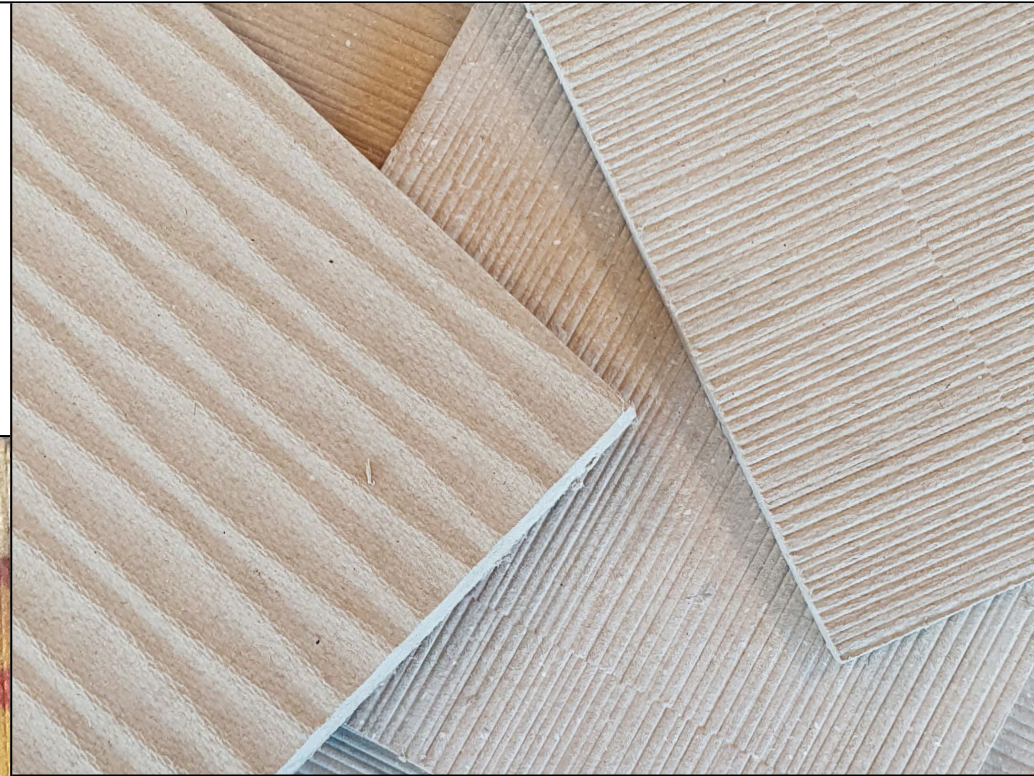
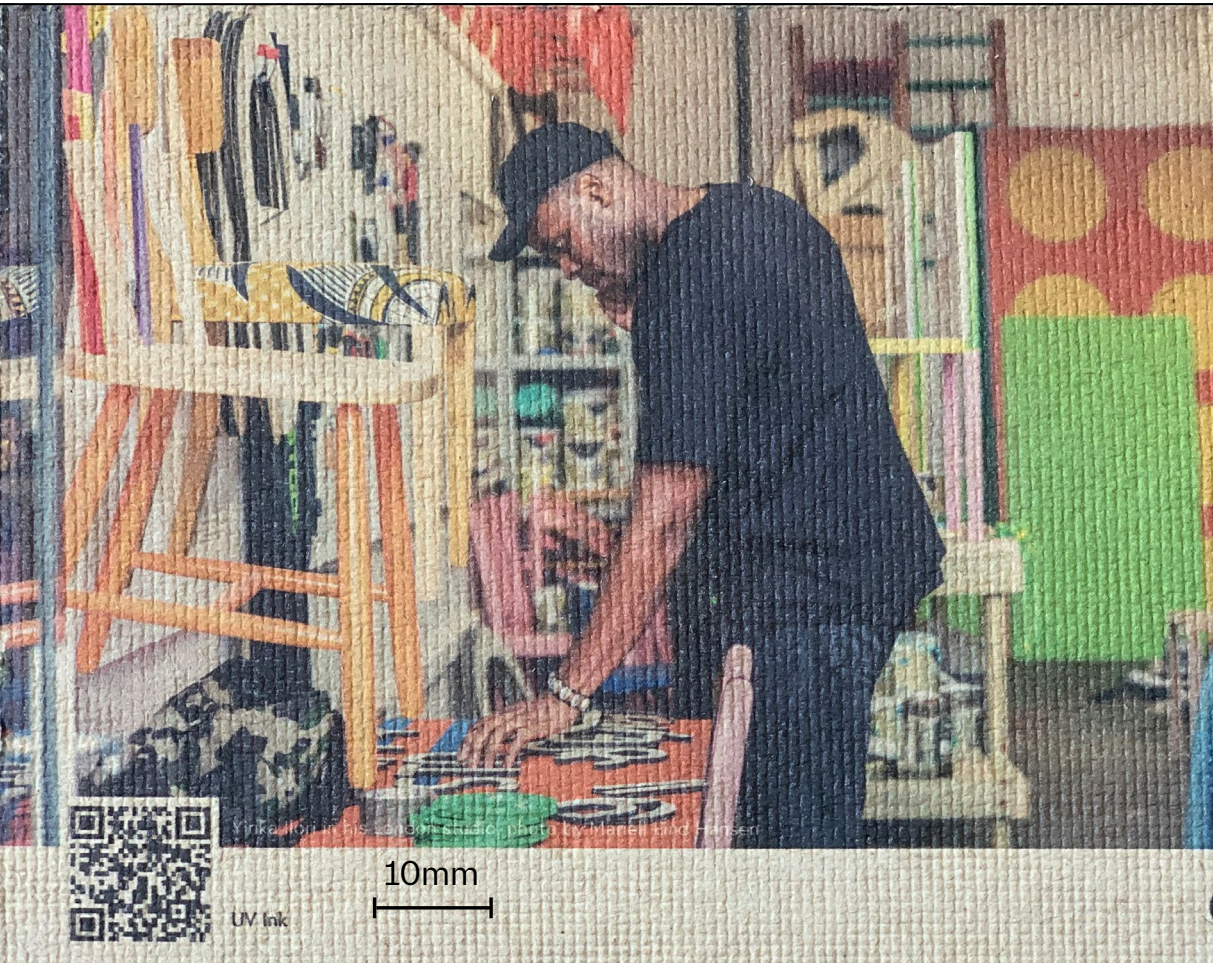

### B. TEXTURING

HONEXT® can be textured in a traditional manner using moulds and a hot press. The low density allows the material to form easily without returning to its original shape.

Pressure: 100 - 500 kg/m<sup>3</sup>

Temperature: 95 °C

Time: 280 sec



## 7. Maintenance

### A. PRESERVING AND CLEANING

HONEXT® Boards mostly have a surface finish applied. For regular, everyday maintenance, please check the surface finish specifications. If not indicated, for regular maintenance use a dry cloth or vacuum. For more thorough cleaning, use a moistened cloth with a soft degreaser, then wipe it with a dry cloth. Contact with oily substances must be avoided.

- Avoid using sponges made of steel or other abrasive materials that would scratch the surface
- Avoid banging or cutting the surface with blunt objects which could scratch it and remove its protective layer
- Do not use alcohol, stain removers, thinners, acetone, trichloroethylene, ammonia, bleach, vinegar, anti-limescale cleaners or any other fluid containing these substances
- Do not use abrasive powder cleaners or detergents which could ruin the aesthetic appearance and surface finish of the product
- Do not concentrate on one area when cleaning the surface, as this may alter its appearance
- Do not drag objects across the surface to avoid scratching

### B. REPAIRS

To repair bumps or deep scratches, wood putty can be applied. If installed, the panel should be painted with plastic, enamelled or thixotropic paint to obtain a homogeneous colouration both on the original surface and on the areas covered by putty. If the material has not been previously sanded, caulking makes it lose its texture, making repairs visible. These wood putties allow for the recycling of the material if they are applied in small quantities - not exceeding 5% of the panel's total volume.

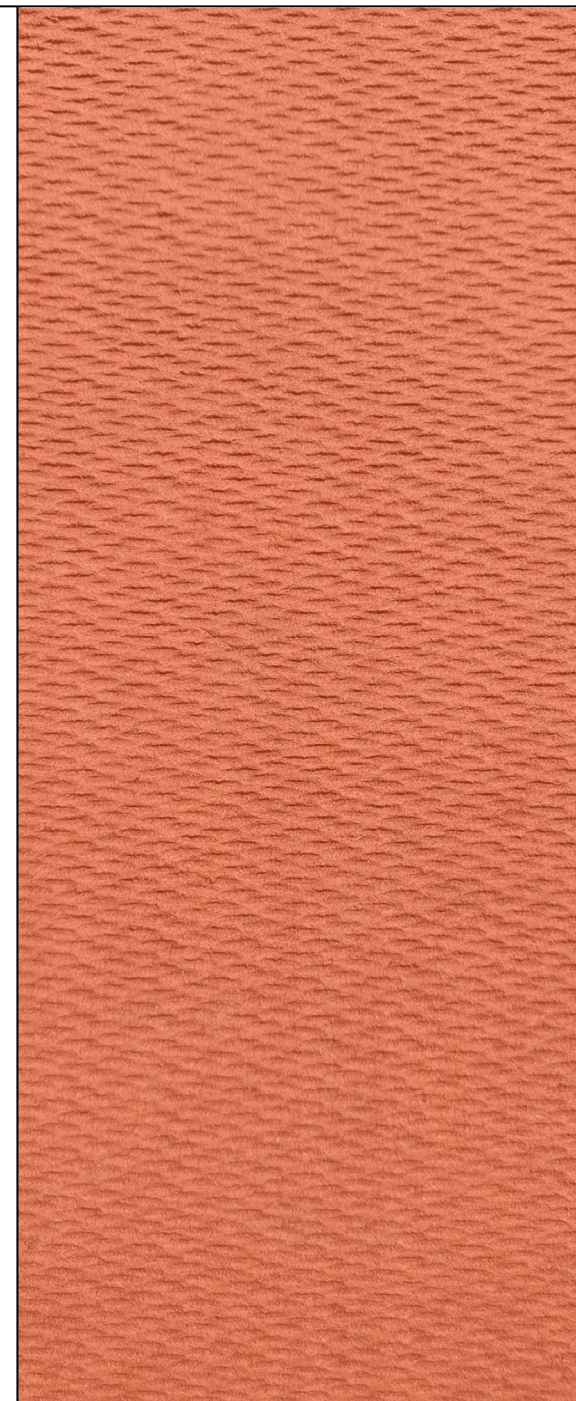

# 8. Transportation and storage

## A. HANDLING

HONEXT® Boards must be handled carefully to avoid any damage. The boards should always be lifted by two persons and not dragged along other surfaces. Never let the weight of the board rest on one corner. Never stack the boards up to a wall to avoid unwanted curvature.

## B. STORAGE

HONEXT® pallets should contain a maximum of 30 boards. They must be stacked flat with the front side facing up (the front side is shown in section 2). Always store HONEXT® Boards in indoors protected from the elements. Without high temperature and humidity levels, always avoiding sudden changes in these conditions.

## C. TRANSPORTATION

The boards must be flat, secured, dry and protected from impact during transportation. Protection sheets are required on both faces of the stack. Use of pallets is ideal for batches to be lifted and handled without damaging the material. If the boards have been cut to lengths, they must be stacked by dimensions. The edges must be protected whenever the material is handled and packed.

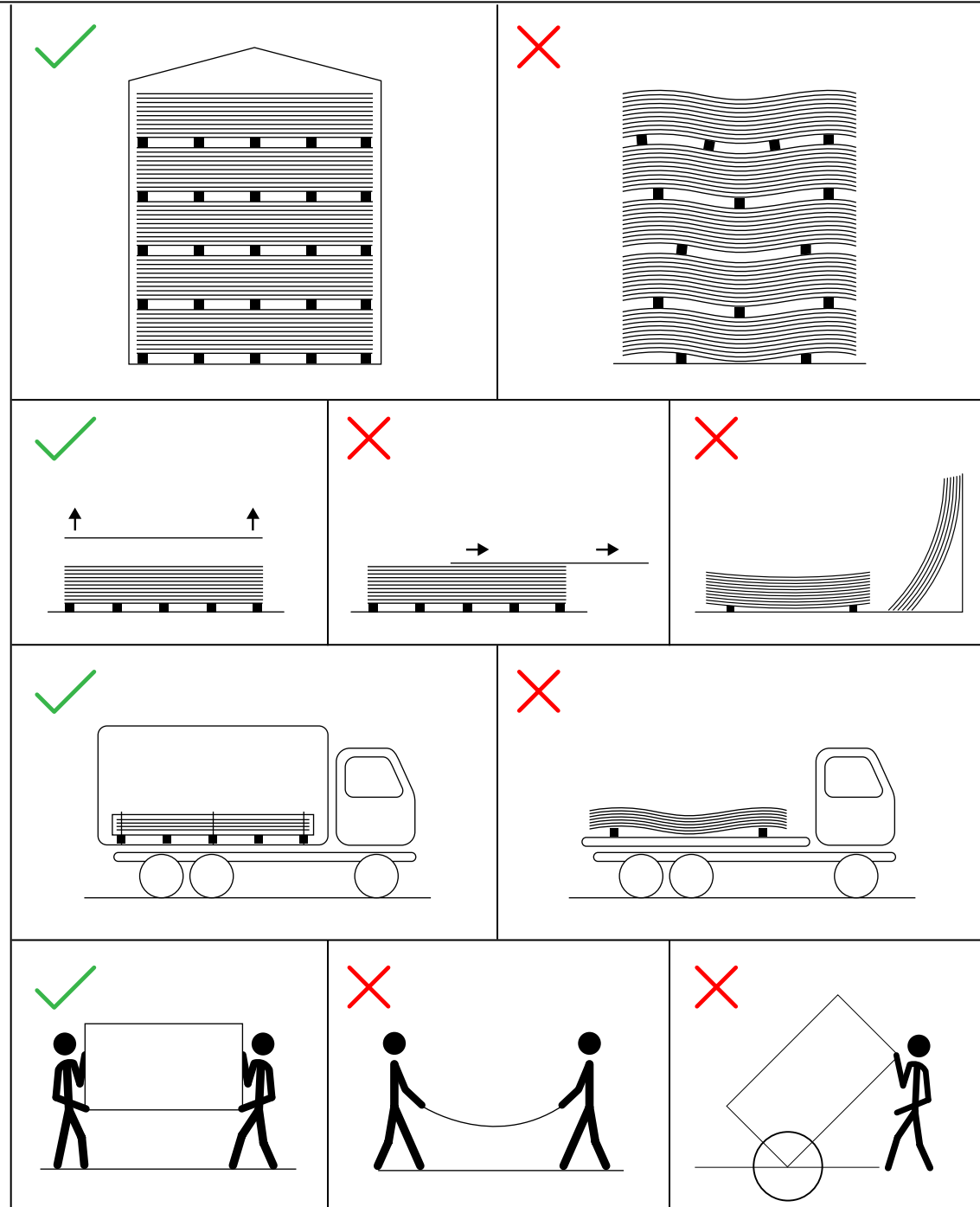

## 9. Circular by design

HONEXT material uses industrial residual fibres from papermaking and cardboard as raw material, and transforms that for new use.

Through our resin-free biotech process, waste is upcycled into boards for interior construction. Both production scraps and boards that reached their end of life, can be fed back into production for a new HONEXT generation products.

The material is designed to never become waste again, achieving Cradle to Cradle Certificate® GOLD, the world's most ambitious standard for making and verifying products that enable a desirable future for all.

### OUR ADVICE

HONEXT® Boards can be transformed using standard equipment and processes and products commonly used for wood-based boards, thus adapting to the needs of the industry and the market. However, at HONEXT® we recommend always using products and finishes that are aligned with our material's sustainability standards.

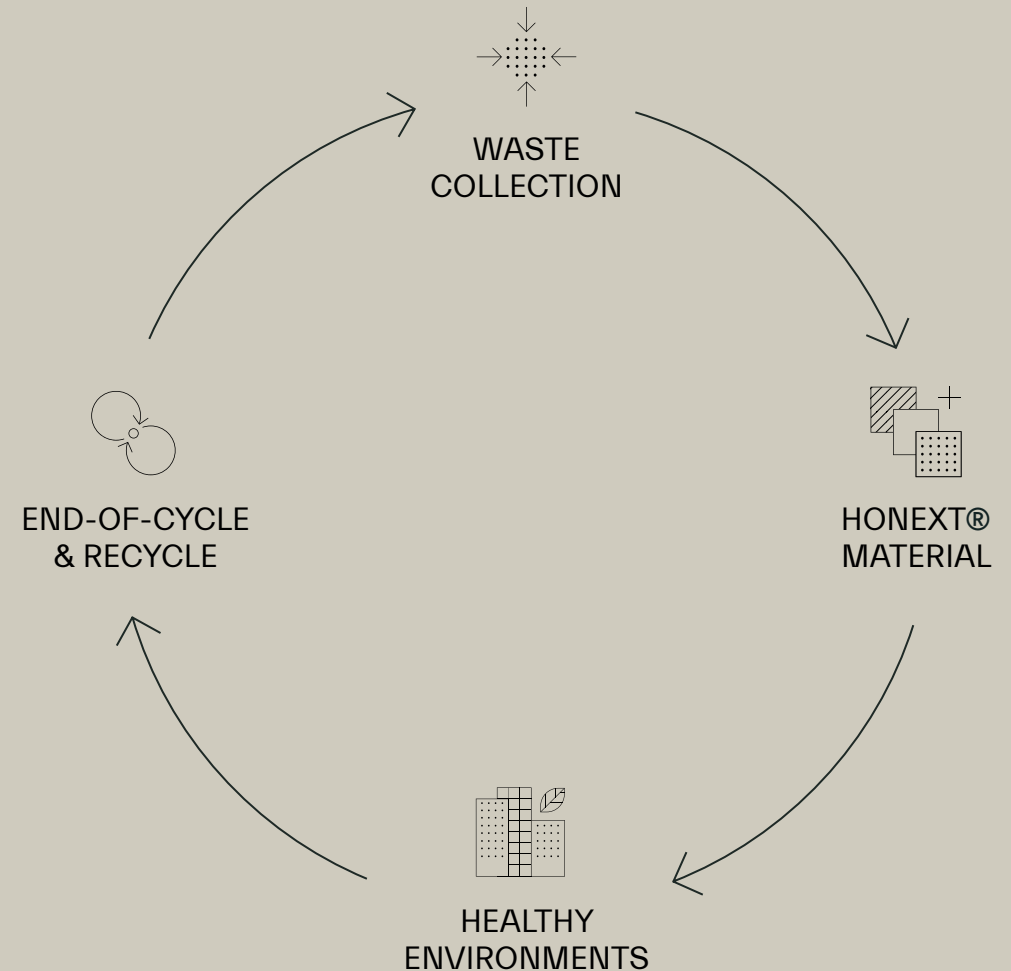



## 10. Relevant information

This leaflet is provided for information purposes only and no liability or responsibility of any kind is accepted by Honext Material S.L. or their representatives. Honext Material S.L. have used reasonable efforts to verify the accuracy of any advice, recommendation or information. Honext Material S.L. reserves the right to alteration of its products, production information and range without notice. As we continually update our technical datasheets please check on [www.honextmaterial.com](http://www.honextmaterial.com) to ensure you have the latest version

For any query or clarification contact [info@honextmaterial.com](mailto:info@honextmaterial.com) or [+34 623 379 238](tel:+34623379238).

This leaflet has been produced by:

Honext Material S.L.

B65494072

C/ d'Aragó, 383, 10ma

08013, Barcelona